

The D3W is a 3-chamber, electrically controlled 4/3 or 4/2 way directional control valve. It is activated directly by solenoids with screwed in wet pin armature.

The soft shifting of this valve is achieved by damping the plunger in the tube with an orifice.

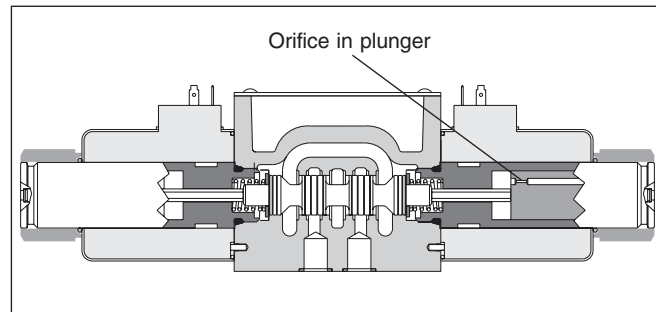
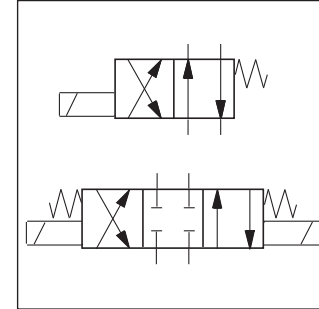
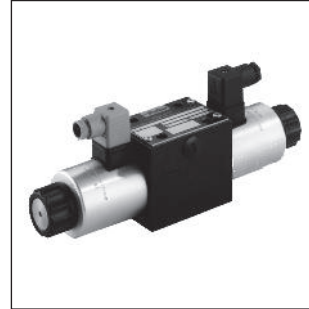

2

Technical data

General					
Design		Directional spool valve			
Actuation		Solenoid			
Size		DIN NG10 / CETOP 05 / NFPA D05			
Mounting interface		DIN 24340 A10 / ISO 4401 / CETOP RP 121-H / NFPA D05			
Mounting position		Unrestricted, preferably horizontal			
Ambient temperature	[°C]	-25...+50			
Weight	[kg]	4.8 (1 solenoid), 6.3 (2 solenoids)			
Hydraulic					
Max. operating pressure	[bar]	P, A B: 350 T: 210 (DC)			
Fluid		Hydraulic oil in accordance with DIN 51524 / 51525			
Fluid temperature	[°C]	-25 ... +70			
Viscosity permitted	[mm ² /s]	2.8...400 (2.8...400 cSt)			
Viscosity recommended	[mm ² /s]	30...80			
Filtration		ISO 4406 (1999); 18/16/13 (meet NAS 1638: 7)			
Flow max.	[l/min]	150 (DC)			
Leakage at 50 bar	[ml/min]	Up to 20 per flow path, depending on spool			
Static / Dynamic					
Step response at 95%	[ms]	See table response time			
Electrical characteristics					
Duty ratio		100% ED; CAUTION: coil temperature up to 150 °C possible			
Protection class		IP 65 in accordance with DIN 40050 (plugged and mounted)			
	Code	K	J	U	G
Supply voltage / ripple	[V]	12 VDC	24 VDC	98 VDC	205 VDC
Tolerance supply voltage	[%]	±10	±10	±10	±10
Current consumption hold	[A]	3	1.5	0.37	0.18
Power consumption hold	[W]	36	36	36	36
Solenoid connection		Connector as per EN 175301-803, solenoid identification as per ISO 9461.			
Wiring min.	[mm ²]	3 x 1.5 recommended			
Wiring length max.	[m]	50 recommended			

With electrical connections the protective conductor (PE ⚡) must be connected according to the relevant regulations.

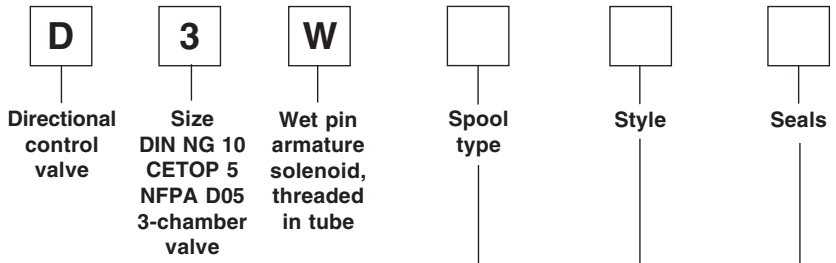

2

3 position spools	
Code	Spool type
1	
2	
3	
4	
5	
6	
7	
10	
11	
12	
14	
15	
16	
21	
22	
31	
32	
81	
82	
102	

3 position spools	
Code	Spool type
8	
9	

2 position spools	
Code	Spool type
20	
26	
30	
101	

3 position spools (except spool 8 and 9)	
Code	Description
C	3 positions. Spring offset in position "0". Operated in position "a" or "b".
E	2 positions. Spring offset in position "0". Operated in position "a".
F	2 positions. Spring offset in position "b". Operated in position "0".
K	2 positions. Spring offset in position "0". Operated in position "b".
M	2 positions. Spring offset in position "a". Operated in position "0".

3 position spools (only for spool 8 and 9)	
Code	Description
C	3 positions. Spring offset in position "0". Operated in position "a" or "b".
E	2 positions. Spring offset in position "0". Operated in position "b".
F	2 positions. Spring offset in position "a". Operated in position "0".
K	2 positions. Spring offset in position "0". Operated in position "a".
M	2 positions. Spring offset in position "b". Operated in position "0".

2 position spools	
Code	Description
B	2 positions. Spring offset in position "b". Operated in position "a".
D	2 positions, detent. Operated in position "a" or "b". No centre or offset position.
H	2 positions. Spring offset in position "a". Operated in position "b".

Code	Seals
N	NBR
V	FPM

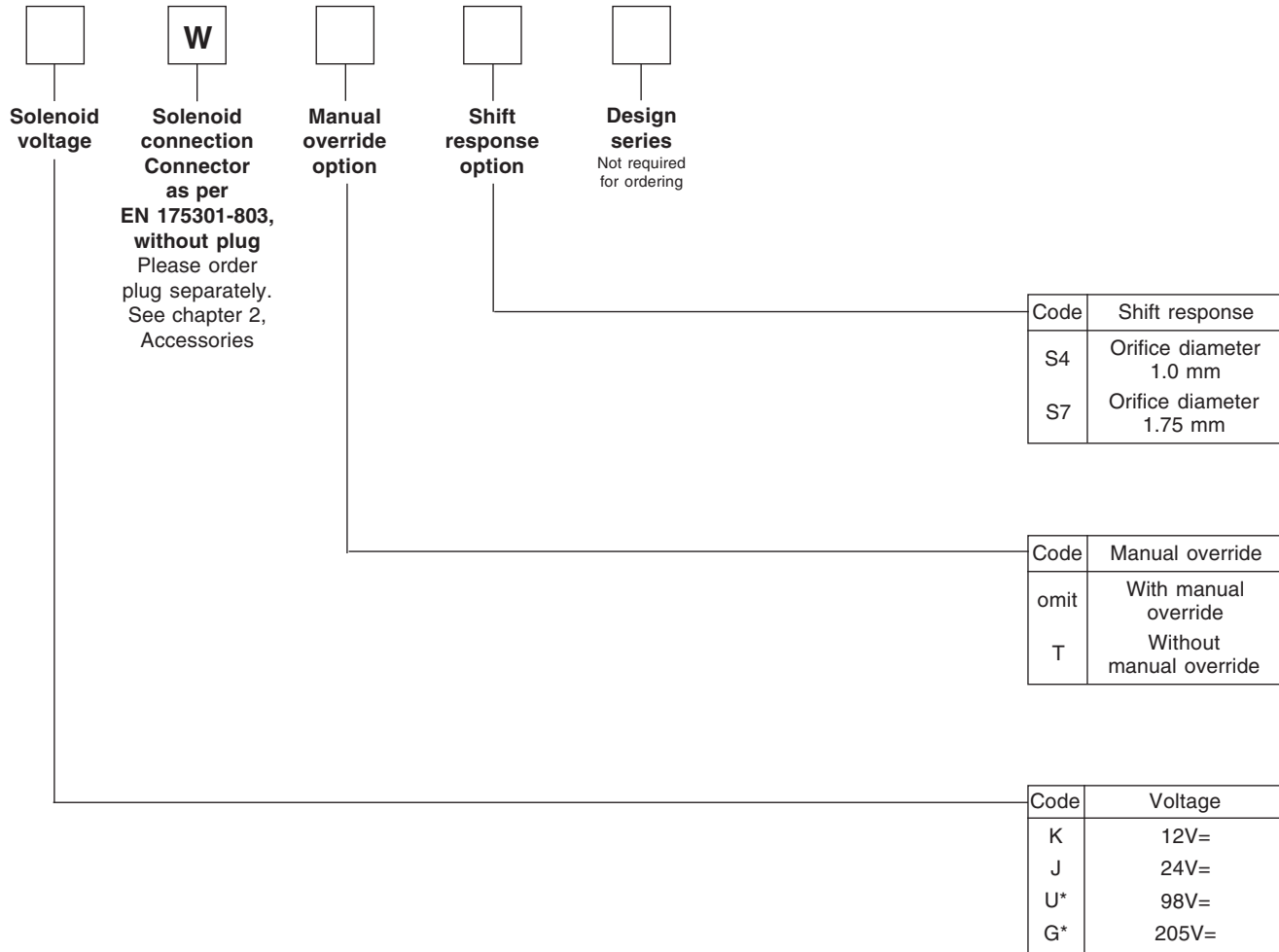

Solenoid connection
 Connector as per
EN 175301-803,
 without plug
 Please order
 plug separately.
 See chapter 2,
 Accessories

* For AC voltage use plug with rectifier.
 Please order rectifier plug separately.

Further spool types, styles and voltages on request.

The flow curve diagram shows the flow versus pressure drop curves for all spools shown. To read the values in the diagram, the curve number for the selected spool and

desired operating position must first be determined from the table below.

2

Spool	Position "b"		Position "a"		Position "0"					
	P->A	B->T	P->B	A->T	P->A	P->B	A->T	B->T	P->T	A->B
1	4	3	4	3	-	-	-	-	-	-
2	4	1	4	1	3	3	1	1	5	1
3	4	3	5	2	-	-	4	-	-	-
4	4	2	4	2	-	-	3	3	-	5
5	4	3	5	3	5	-	-	-	-	-
6	4	3	4	3	6	6	-	-	-	6
7	5	1	4	3	-	4	-	2	6	-
10	4	-	4	-	-	-	-	-	-	-
11	4	3	4	3	-	-	8	8	-	-
12	4	3	4	3	7	7	7	7	8	8
14	4	3	5	1	4	-	2	-	6	-
15	5	2	4	3	-	-	-	4	-	-
16	5	3	4	3	-	5	-	-	-	-
20	4	3	4	3	-	-	-	-	-	-
26	4	-	4	-	-	-	-	-	-	-
30	4	2	4	2	-	-	-	-	-	-
	P->B	A->T	P->A	B->T	P->A	P->B	A->T	B->T	P->T	A->B
8	4	3	4	3	-	-	-	-	6	-
9	4	4	4	4	-	-	-	-	6	-
	Position "b"		Position "a"							
	P->A	P->B	A->B	P->B	A->T					
21	5	4	6	3	3					
	P->A	B->T		P->A	P->B	A->B				
22	3	3		4	5	6				

Flow curve

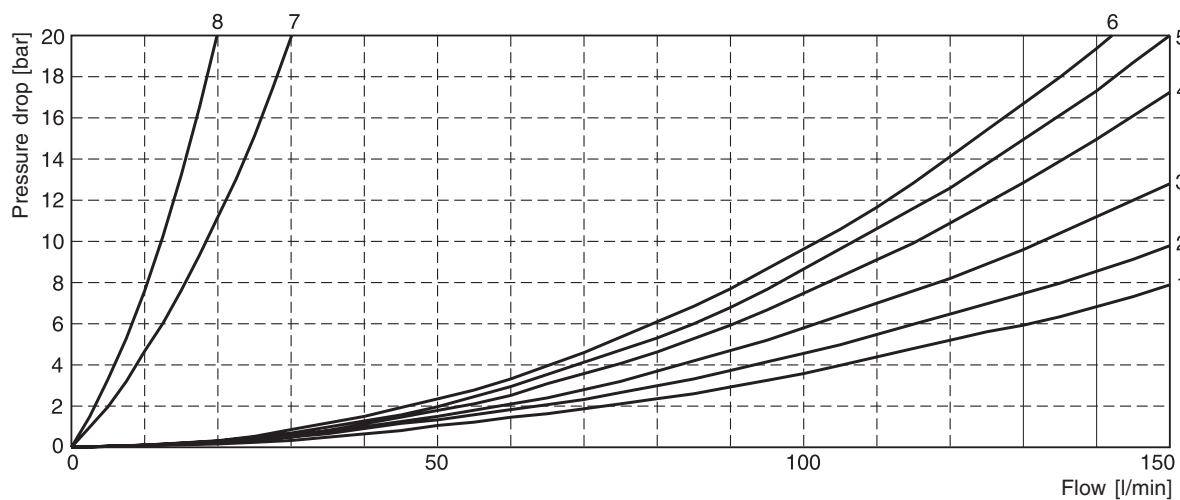

D3W SOFT SHIFT.PMD RH



Shift limits

The diagram below specifies the shift limits for valves with DC solenoids. Valves of style "F" and "M" may only be loaded at 70% of the value. The specifications apply to a viscosity of 35 mm²/s and equal flow at A and B port.

These values can be considerably lower than the represented ones by unequal flow at A and B port. To avoid flow rates above the shift limits of the valve, a plug-in orifice can be inserted in the P port.

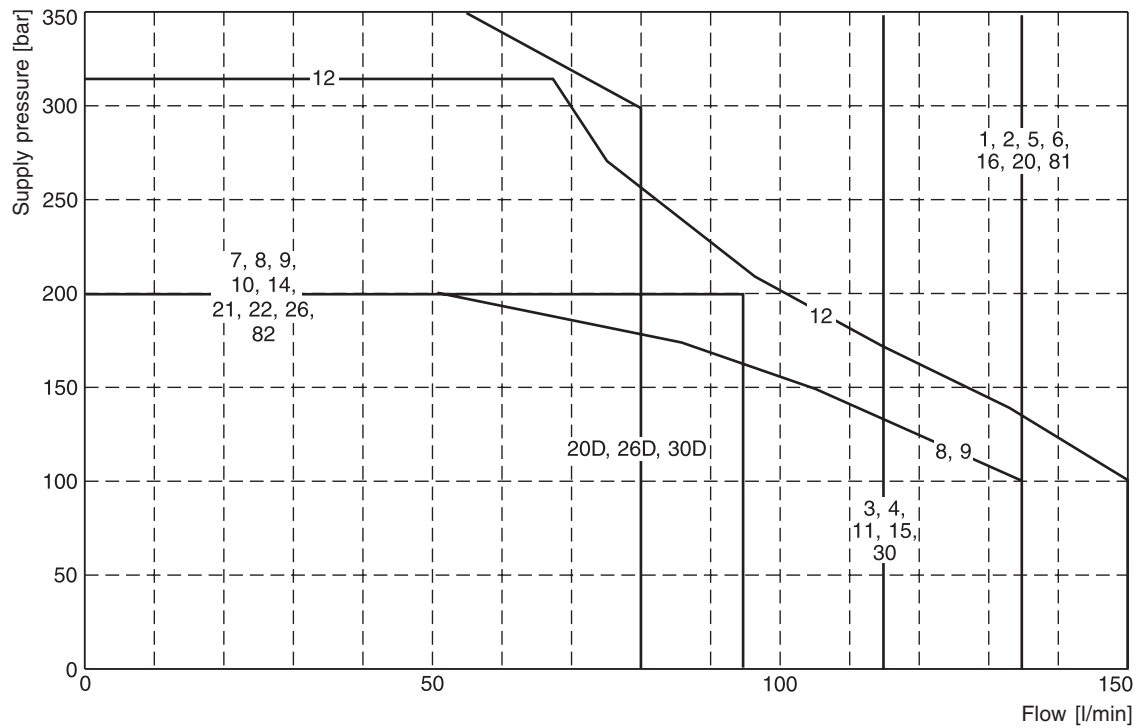

Measured at 90% U_{nom} and warm solenoids.

2

Response times D3W Soft Shift

Code	Orifice size	Energize	Deenergize
S4	1.0 mm	320 ms	550 ms
S7	1.75 mm	160 ms	370 ms

Step response times were obtained under the following conditions: $\nu = 35 \text{ mm}^2/\text{s}$ at 50°C with the valve operating at 175 bar and 65 l/min. Published response times are nominal and may vary with spool, flow, pressure and temperature.

Acceleration for different orifice sizes (archived against a valve without soft shift)



For even softer shifting, the proportional spools 81, 82, 101 and 102 can be used.

D3W SOFT SHIFT.PMD RH



2

**Interface EN 175301-803, DC-solenoid
 B, E, F -style**

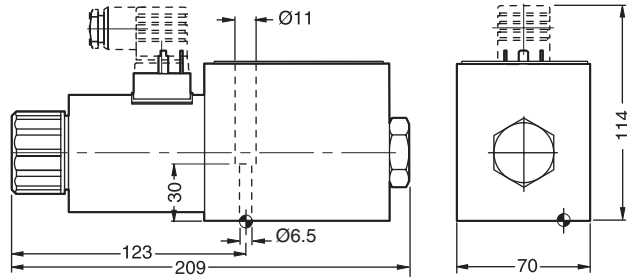



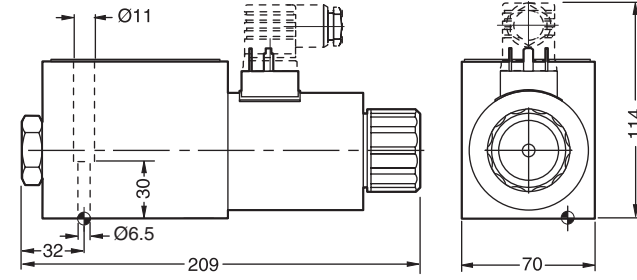

H, K, M -style

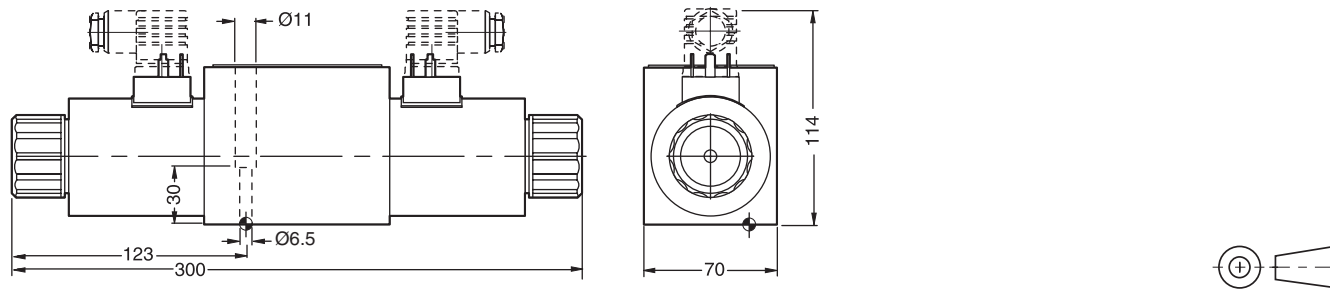

C, D -style

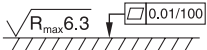

Surface finish	 Kit			 Kit
	BK385	4x M6x40 DIN 912 12.9	11 Nm ± 15%	NBR: SK-D3W-30 FPM: SK-D3W-V30

The space necessary to remove the plug per EN 175301-803, design type AF is at least 15 mm.
 The torque for the screw M3 of the plug has to be 0.5 to 0.6 Nm.